



Take
a Good Look
It May Be Your Future



MARS

SERIES 33

Direct Mount
Multi-Port
3-/4-/5-Way Ball Valves
1/4" to 4" Full Port

High Performance
Easy Maintenance
Easy Automation

www.marsvalve.com.tw

DO YOU STILL USE CONVENTIONAL ACTUATOR MOUNTING?

Conventional mounting method is to use a bracket and adapter between ball valve and actuator. However, the bracket and adapter can often be the source of failure for valve/ actuator packages:

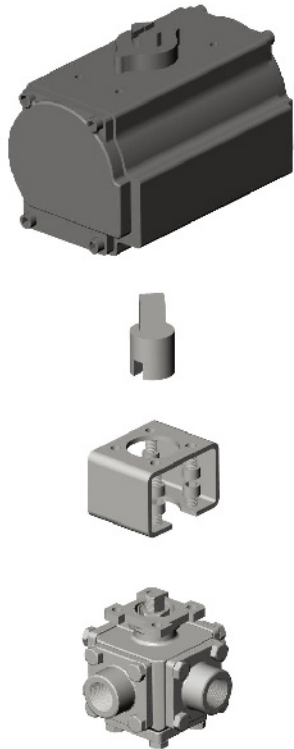

- A simple misalignment of the bracket and adapter can cause excessive wear and high torque than expected, this can result in stem leakage or valve stall.
- A warped bracket, however slightly, or the bolt drillings lose center, stem side loading can occur.
- If the adapter is too long and bracket bolts are drawn down tightly, the adapter can jam the valve stem into valve ball resulting in higher torque than the actuator provided.
- The bracket and adapter leave exposed moving parts, when the adapter turns it can become a pinch point and injury may occur.
- The connections between the adapter and the valve stem and the adapter and the actuator drive can create a slope, known as hysteresis, the looseness of the connecting surface can cause the valve to not fully open or fully close.

MARS DIRECT MOUNT BALL VALVE SETS A NEW STANDARD FOR BALL VALVE/ACTUATOR MOUNTING, ENHANCES FUNCTIONAL PERFORMANCE WITH EASY INSTALLATION AND LOWER MAINTENANCE COSTS.



The new way of mounting actuator is the Direct Mount Configuration, it is designed to overcome the problems of conventional actuator mounting. This design allows an actuator bolted directly to the top of ball valves for greater reliability, easy installation and improved cycling life.



- No bracket and adapter are required, the valve stem is an integral part of the actuator drive. The direct valve stem coupling to actuator shaft ensures correct alignment of the valve to the actuator, minimizes stem side loading and backlash during operation, increased service life and performance.
- **Modular design and simplicity:** No confusion as to how to select brackets and adapters.
- **Low cost and easy automation:** Direct mount eliminates the need for additional brackets and adapters, time and labor saving too.
- In the event maintenance is needed, Mars Direct Mount ball valves facilitate fast, easy breakdown and assembly of ball valve and actuator package, the result is reduced maintenance time and the lowest overall cost of ownership.
- **Compact and Space-Saving:** The close coupling of the actuator to the valve makes the total package as compact as possible.
- **Safety:** There are no External Moving Parts, No Pinch Points.
- **Direct Valve Stem/Actuator Drive Connection:** Less chance for Hysteresis

SERIES 33 DIRECT MOUNT MULTI-PORT 3/4/5-WAY BALL VALVES SIL 3



Construction:	Five-Entry Construction, Full Port		
Size Range:	1/4" (DN 8) to 4" (DN 100): Threaded, Socket Weld, Butt Weld Ends 1/2" (DN 15) to 4" (DN 100): Flanged Ends		
Pressure Rating:	1/4" to 1" : 1000 PSI - 1 1/4" to 2" : 800 PSI - 2 1/2" to 3" : 600PSI – 4" : 300PSI		
Valve Model And End Connections:	SERIES 33 3-WAY	SERIES 33X 4-WAY	SERIES 33Y 5-WAY
	33-10 Threaded	33X-10 Threaded	33Y-10 Threaded
	33-20 Socket Weld	33X-20 Socket Weld	33Y-20 Socket Weld
	33-30 Butt Weld	33X-30 Butt Weld	33Y-30 Butt Weld
	33-40 ANSI Class 150 LB	33X-40 ANSI Class 150 LB	33Y-40 ANSI Class 150 LB
	33-50 ANSI Class 300 LB	33X-50 ANSI Class 300 LB	33Y-50 ANSI Class 300 LB
	33-60 DIN PN 16/40	33X-60 DIN PN 16/40	33Y-60 DIN PN 16/40
	33-70 DIN PN 40	33X-70 DIN PN 40	33Y-70 DIN PN 40
Seat Construction:	Five Seats Design for Equal Seat Loading and Positive Sealing at Any Port		
Ball Configuration:	L-Port, T-Port, X-Port, I-Port, TT-Double T Port, LL-Double L-Port		
Valve Materials:	Standard: ASTM A351- CF8M - EN10213 1.4408 Options: Carbon Steel , CF3M , 1.4409		
Seat Materials:	Standard: R-PTFE Options: PTFE , Carbon filled PTFE , 50/50 PTFE + S.S. , TFM 1600 , MG1241 and UHWMPE		
Valve Surface Finish:	Carbon steel valves: Phosphate Stainless steel Valves: Pickling, Passivation		
Inspection and Test:	API 598, BS6755 Part 1		
Compliance Standards:	EN 12516-1/3 , NPT ASME B1.20.1 , BSPP ISO 228-1 , BSPT ISO 7-1 , DIN 2999 , ASME B16.11 , ASME B16.25 , EN1092-1 , DIN 2543 PN16 , DIN 2544 PN25 , DIN 2545 PN40 , ASME B16.5 CLASS 150 \ CLASS 300 , API 598 , EN 12266-1 , ISO 5211 , ISO 5209		
Test Certificate:	EN 10204 – DIN 50-049.3.1B , TA-LUFT/VDI2240 , ATEX Directive 2014/34/EU SIL 3 Capable , ISO 9001:2008 and API 598 Declaration		
CE Approval :	PED 2014/68/EU Module H		
NACE MR-01-75 :	Optional		
Quality Control:	ISO 9001		

Mars Unique SealMax® Stem Design - Maintenance Free - Triple-Sealing System - Live Loaded Stem Packing - Extremely High Cycle - provides optimum stem seals

1. PYRAMIDAL STEM WITH STEM SEAL

First stage of defense against leakage. The 45 degree slope of the stem accompany the stem seal effectively blocks all leak path during rotation.

2. O-RING STEM PACKING

Second stage of defense against leakage, enhances stem seal and maintains stem alignment, provides extra longer service life.

3. V-RING STEM PACKING

Third stage of defense against leakage, multiple layers of V-Ring Chevron Packing expands side way as it is being compressed, blocking all air pockets to prevent leak path.

4. LOCK SADDLE

Stabilizes the entire stem nut to keep it from loosening during operation.

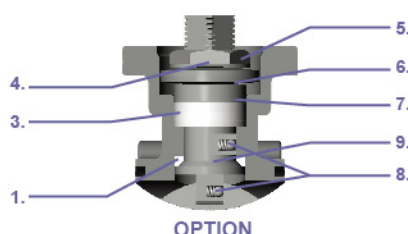
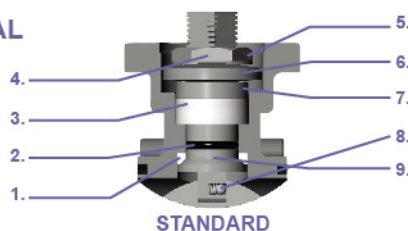

5. STEM NUT

Compress the entire stem system to enable blocking of leakage.

6. BELLEVILLE WASHERS

Automatically compress the seals to adjust for wear, pressure, and temperature fluctuations.

7. GLAND

Made of stainless steel, equally distributes the compressive force on the packing and seal.

8. ANTI-STATIC DEVICE

Ball-to-stem anti-static device as standard; the stem-to-body anti-static device is optional.

9. SUPER SMOOTH STEM FINISH

Reduces seal friction and operating torque, prolongs service life.

MARS SERIES 33 DIRECT MOUNT MULTI-PORT 3/4/5-WAY BALL VALVES OFFER SUPERIOR PERFORMANCE AND RELIABILITY REQUIRED TO OPTIMIZE MANUAL AND AUTOMATION PROCESS PERFORMANCE

■ DESIGN FEATURES

- **Dual Pattern ISO 5211 Mounting Pad With Square Shaft**
No bracket and adapter are required for actuator mounting, provides easy and low cost automation with improved cycle life
- **5-Seat Construction**
For equal seat loading and positive sealing at any port, and maintain proper ball alignment.
- **Five-Entry Construction, Bottom Entry is ready**
- **O-Ring Stem Seal**
Enhances stem wear and maintains stem alignment
- **Anti-Static Device**
Standard applied stem-to-ball; stem-to-body anti-static device as optional
- **Variety of End Connections Available for options**

● Stem

- Mars SealMax® Stem packing arrangement provides optimum stem seal and extremely high cycle life
- Super smooth stem surface reduces seal friction and operating torque
- Blow-out proof stem prevents stem from blowing out, for maximum safety

● Ball

Precisely machined, mirror polished solid ball for bubble tight shut off with less operating torque

● Seats

- Wide range of seat materials available to suit various applications



*PATENTED!

BALL AND STEM CONNECTIONS

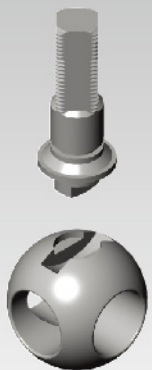

Semi-Trunnion Ball Design produced a locked ball-to-stem connections offering a positive connection that effectively eliminates mechanical backlash and hysteresis, the splined connection ensures accurate, precise positioning of the ball and lower operating torque for better actuation.

*PATENTED!

END CAP AND BODY CONNECTIONS



The conventional end cap and seat retainer was one piece design that made the end caps extended into valve body, creates a problem when repair and maintenance required, it is very difficult to remove end caps from valve body when valves mounted on pipeline, especially when ball valves was welded on pipeline.

Mars Patented End Cap Design is separated from Seat Retainer in Two-Piece Easy-to-Maintain Construction



It is designed to overcome the problem of the conventional end cap design, easily remove end caps from valve body when valves mounted on pipeline, allows fast and easy replacement of gasket and seats that enhances functional performance with lower installation / maintenance costs.

*PATENTED!

MARS SERIES 33 5-PIECE DESIGN CAVITY FILLED SEATS



The cavity filled seats are designed to fill the dead space between the ball and valve body, minimize problems with trapped fluid in the valve body that can contaminate the process. Mars Cavity Filler Seats fill 95% of the dead space between valve body and ball, while others' cavity filled seats of 3/4/5-way ball valves can only fill maximum 80% of the dead space

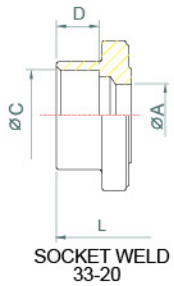
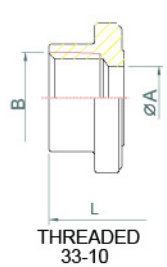
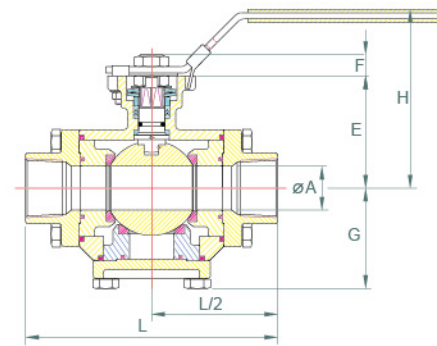
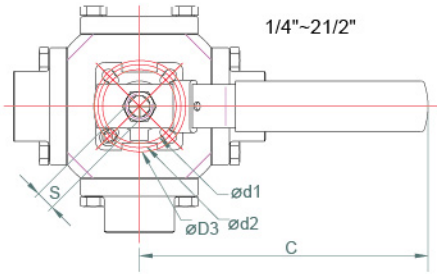

DIMENSIONS (mm) FULL PORT

SIZE	øA	S	C	E	F	G	H	L	ød1	ød2	øD3	Wt.(kg)	ISO5211
1/4"	11.6	9	150	43.9	9	35.1	85	92	36	42	50	1.4	F03/F04/F05
3/8"	12.7	9	150	43.9	9	35.1	85	92	36	42	50	1.4	F03/F04/F05
1/2"	15	9	150	43.9	9	35.1	85	92	36	42	50	1.3	F03/F04/F05
3/4"	20	11	165	54.2	10.5	45.3	93	110	42	50	50	2.81	F04/F05
1"	25	11	180	64.1	10.5	56.8	108	144	42	50	70	4.76	F04/F05/F07
1 1/4"	32	14	215	78.5	13	59.8	127	146	50	70	70	5.75	F05/F07
1 1/2"	38	17	263	94.9	18.0	72.3	152	164	70	102	102	10.56	F07/F10
2"	50	17	313	101.6	18.0	80.5	159	184	70	102	102	13.42	F07/F10
2 1/2"	65	17	344	120	18.0	96.8	177	228	70	102	102	21.31	F07/F10
3"	76	22	370	132.9	23	105	195	265	102	125	125	28.85	F10/F12
4"	100	22	510	164	23	131.5	226	317	102	125	125	57.51	F10/F12

Breakaway Torque(RPTFE) & Cv Value

SIZE	Nm	Inch-Lb	Cv Value L-PORT	Cv Value T-PORT
1/4"	9	81	4	7
3/8"	9	81	5	9
1/2"	9	81	6	10
3/4"	17	151	16	21
1"	29	257	31	36
1 1/4"	35	310	32	58
1 1/2"	59	523	75	90
2"	72	638	140	175
2 1/2"	92	815	210	235
3"	198	1,754	375	450
4"	250	2,215	670	800

Break Away Torque(RPTFE)
30% safety factor included.
Standard Mars valves are assembled with silicon-free based in lubricant, Torque for dry assembled valves please consult factory.

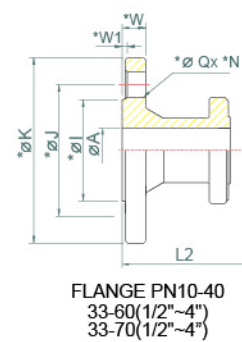
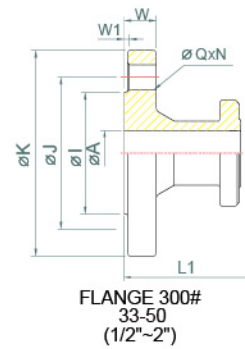
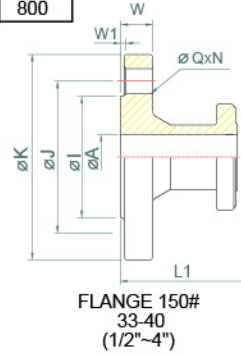
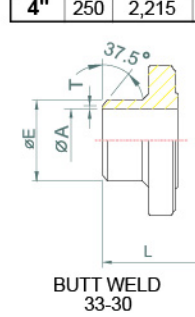

DIMENSIONS (mm)

SIZE	øA	B	øC	D	øE	T	øI	øJ	øK	øQ	N	W	W1	L1	øI	øJ	øK	øQ	N	W	W1	L1	*øI	*øJ	*øK	*øQ	*N	*W	*W1	L2	*øI	*øJ	*øK	*øQ	*N	*W	*W1	L2								
1/4"	11.6	NPT	14.3	10	16.2	1.6	1/2"-4" 150LBS										(1/2"-2") 300LBS										2 1/2"-4" PN16										(1/2"-4") PN40									
3/8"	12.7		17.6	10	17.5	1.6																																								
1/2"	15	PT	21.9	10	22.7	1.6	35.1	60.5	88.9	16	4	11.2	1.6	150	35.1	66.5	95.3	16	4	14.3	1.6	160	45	65	95	14	4	16	2	165	45	65	95	14	4	16	2	165								
3/4"	20		27.3	13	27.5	1.6	42.9	69.9	98.6	16	4	11.2	1.6	175	42.9	82.6	117.3	19	4	15.8	1.6	190	58	75	105	14	4	18	2	190	58	75	105	14	4	18	2	190								
1"	25	DIN259	33.9	13	34	1.6	50.8	79.2	108	16	4	11.2	1.6	205	50.8	88.9	124	19	4	17.6	1.6	215	68	85	115	14	4	18	2	220	68	85	115	14	4	18	2	220								
1 1/4"	32	DIN2999	42.8	13	42.7	1.6	63.5	88.9	117.3	16	4	12.7	1.6	215											78	100	140	18	4	18	2	235	78	100	140	18	4	18	2	235						
1 1/2"	38	ISO228	48.9	13	48.6	1.6	73.2	98.6	127	16	4	14.3	1.6	255	73.2	114.3	155.4	22.2	4	20.6	1.6	270	88	110	150	18	4	18	3	270	88	110	150	18	4	18	3	270								
2"	50		61.3	16	60.5	1.6	91.9	120.7	152.4	19	4	15.9	1.6	280	91.9	127	165.1	19	8	22.4	1.6	290	102	125	165	18	4	20	3	290	102	125	165	18	4	20	3	290								
2 1/2"	65	BSP	61.3	16	76.3	2	104.6	139.7	177.8	19	4	17.6	1.6	325											122	145	185	18	4	18	3	330	122	145	185	18	4	18	3	330						
3"	76		90	16	90	2	127	152.4	190.5	19	4	19.1	1.6	345											138	160	200	18	8	20	3	340	138	160	200	18	8	24	3	340						
4"	100	115.5	20	116	3.5	157.2	190.5	228.6	19	8	23.9	1.6	403											158	180	220	18	8	20	3	403	162	190	235	22	8	24	3	403							

NOTE: Standard Mars valves are assembled with silicon-free based in lubricant, for degreasing or other options, please consult factory.

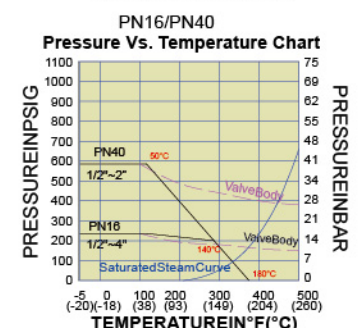
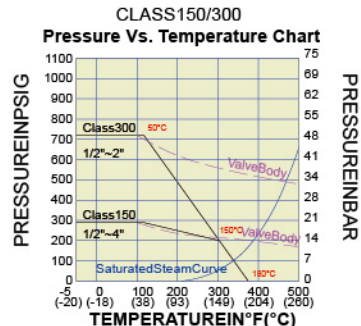
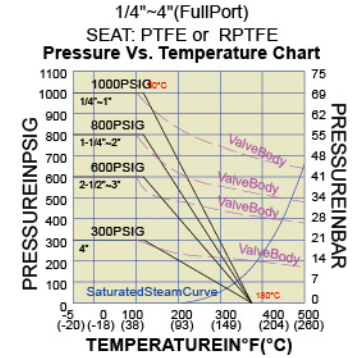
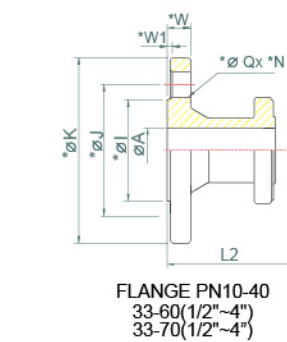
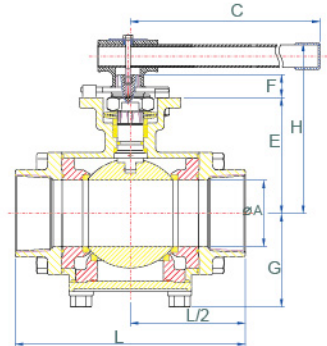
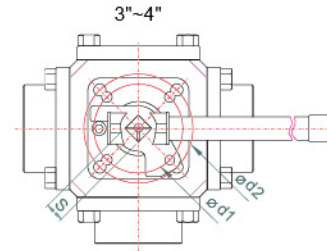

MATERIALS OF CONSTRUCTION

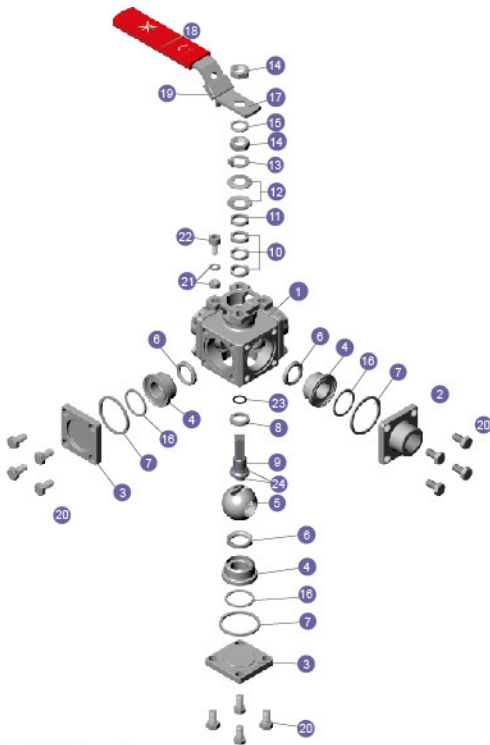

MATERIALS LIST

NO.	PART NAME	MATERIAL	QTY
1	Body	CF8M / WCB	1
2	End Cap-A	CF8M / WCB	3
3	End Cap-B	CF8M / WCB	2
4	Seat Retainer	CF8M / WCB	5
5	Ball	SUS 316 / CF8M	1
6	Seat	PTFE/RTFE	5
7	Joint Gasket	PTFE	5
8	Stem Seal	RPTFE	1
9	Stem	SUS 316	1
10	Stem Packing	25% Glass Fiber Filled +PTFE	1 SET
11	Gland	SUS 304	1
12	Belleville Washer	SUS 301	2
13	Lock Saddle	SUS 304	1
14	Stem Nut	SUS 304	2
15	Stem Washer	SUS 304	1
16	Retainer Seal	PTFE	5
17	Handle	SUS 304	1
18	Handle Sleeve	VINYL	1
19	Locking Device	SUS 304	1
20	Bolt Nut	SUS 304	20
21	Pin Nut& Washer	SUS 304	1
22	Stop Pin	SUS 304	1
23	O-Ring	VITON	1
24	Antistatic - Device	SUS 316	2

MARS TOP WORKS MAKE AUTOMATION AS EASY AS IT GETS

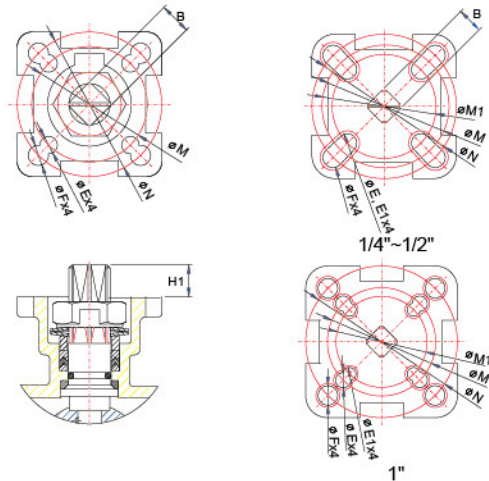

DIMENSIONS (mm)

Dimension B: 17/19 Standard 17, Option 19

SIZE	B	H1	øM1	øM	øN	øE1	øE	øF	ISO5211
1/4"	9	9	36	42	50	6.5	6.5	7	F03/F04/F05
3/8"	9	9	36	42	50	6.5	6.5	7	F03/F04/F05
1/2"	9	9	36	42	50	6.5	6.5	7	F03/F04/F05
3/4"	11	10.5	42	50	70	6	7	9	F04/F05
1"	11	10.5	42	50	70	6	7	9	F04/F05/F07
1-1/4"	14	13	42	50	70	6	7.5	9	F05/F07
1-1/2"	17	19	42	70	102	10	12	12	F07/F10
2"	17	19	42	70	102	10	12	12	F07/F10
2-1/2"	17	19	42	70	102	10	12	12	F07/F10
3"	22	23	42	102	125	12	14	14	F10/F12
4"	22	23	42	102	125	12	14	14	F10/F12

SERIES 33 BALL VALVES WITH MARS "TSM" UNIT ADD EXTRA SAFETY AND HIGH CYCLE LIFE

MARS TSM UNIT

A Fugitive Emission Bonnet compliance with EPA and TA-LUFT requirements

DESIGN AVANTAGES

- * Mars TSM unit is 316 SS investment cast and equipped with Mars unique live loading Stem packing:
- * Excellent, cost effective way to provide double sealing, offers dramatically improved cycle life, your best choice for high cycle applications
- * Purge ports are available for the purpose of detecting primary seal leakage, it can be immediately observed and corrective action taken.
- * Easy to insulate
- * Easily mounted to Mars Series 22, 33, 39M, 55, 77, 83, 88, 88A, 90, 90D, 91D and 99 ball valves.
- * ISO 5211 mounting pad and stem orientation allows direct mounting of actuator to valves, No brackets and coupler are required for actuation.

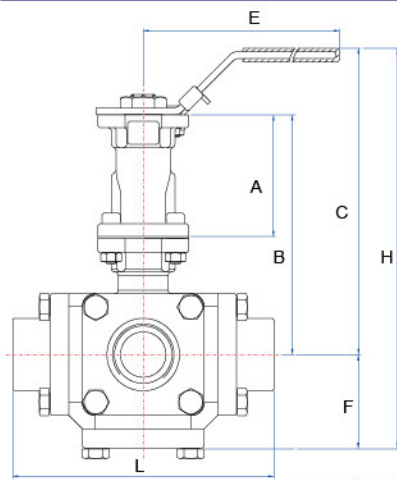

DIMENSIONS (mm)

SIZE	A	B	C	E	F	L	H
1/4"	61.7	105.6	139.9	139	35.1	92	175
3/8"	61.7	105.6	139.9	139	35.1	92	175
1/2"	61.7	105.6	139.9	139	35.1	92	175
3/4"	68	122.2	161.2	165	45.3	110	206.5
1"	68	132.1	171.1	165	56.8	144	227.9
1-1/4"	87	165.5	214.5	215	59.8	146	274.3
1-1/2"	106	200.9	253.9	263	72.3	164	326.2
2"	106	207.6	265.6	313	80.5	184	346.1
2-1/2"	106	226	284	344	96.8	228	380.8
3"	125	257.9	303.9	370	105	265	408.9
4"	125	289	335	510	131.5	317	466.5

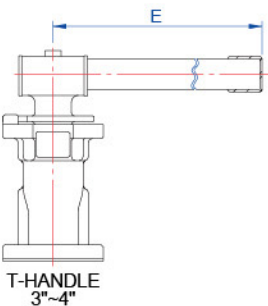

FLOW PATTERN OPTIONS

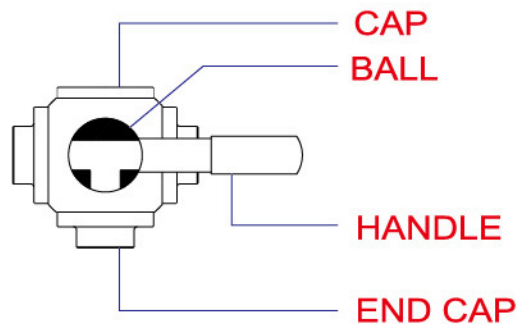
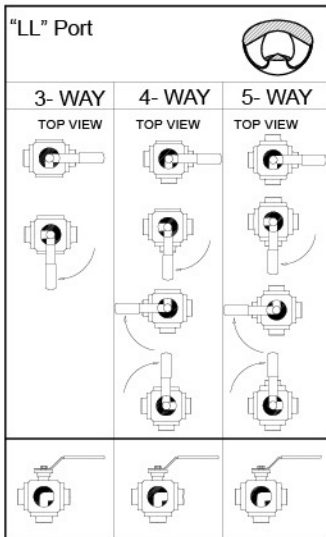
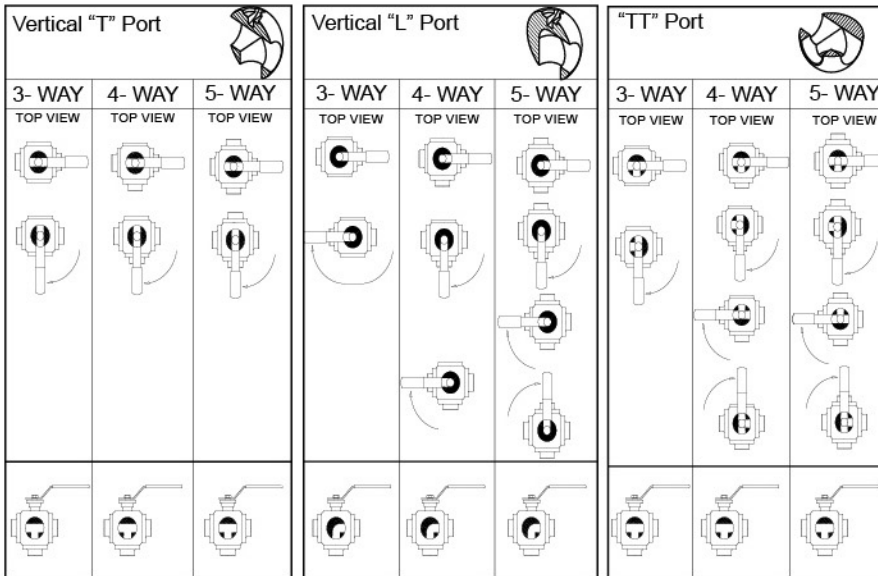
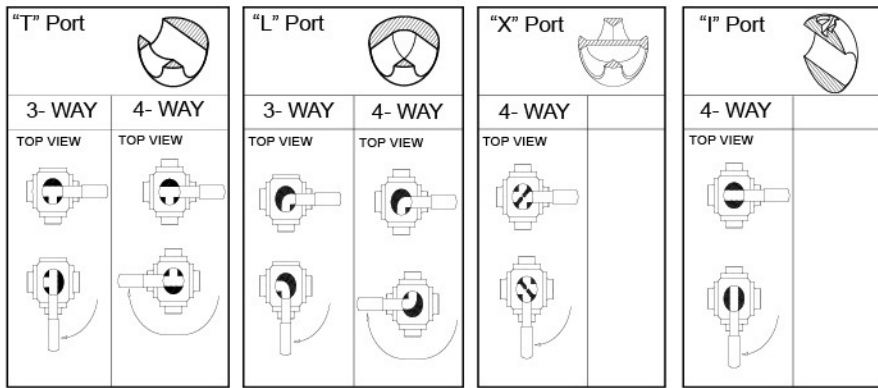

SERIES 33 STANDARD HANDLE

- Plated S.S. handle with vinyl sleeves (1/4" - 2 1/2")



- S.S. T-Handle (3" & 4")



HANDLE OPTIONS

- Mars Spring Return Safety (SRS) Handle
Provides safe and positive fail closed or open operation

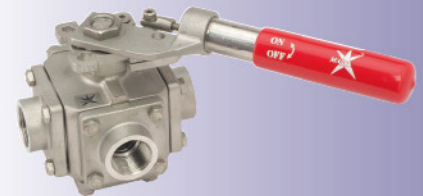

- Spring Return Sliding Lock (SRSL) Handle (1/4" - 2 1/2")

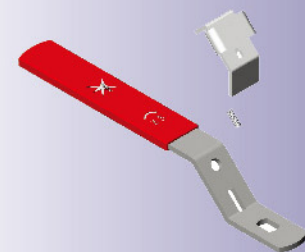

No matter the orientation of the ball valves, the SRSL handle always secures handle in position, make valve operation safe

EASY AUTOMATION

AirMars
Pneumatic Actuator





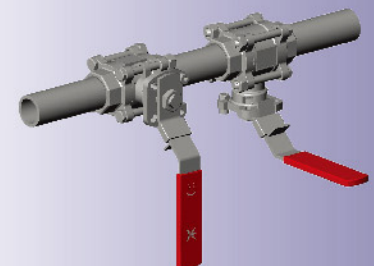





PowerMars
Electric Actuator



*Please consult factory for actuator sizing

MATERIALS OTHER MULTI-PORT 3/4/5-WAY VALVES

	SERIES 30	SERIES 36 DIRECT MOUNT		SERIES 38	SERIES 39 DIRECT MOUNT	SERIES 83D	SERIES 88D DIRECT MOUNT
							
SIZE	1 1/2" - 12"	1/4" - 12"	SIZE	1/4" - 3"	1/4" - 2"	1/4" - 2"	1/2" - 2"
Port	Full port	Reduced-, Full Port	Port	Reduced Port	Reduced-, Full Port	Full Port: 1/4"-2" Reduced Port: 1/2"-2"	Full Port: 1/4"-1/2" Reduced Port: 1/2"-2"
Seat Construction	3-Seat Design	4-Seats Design	Seat Construction	4-Seat Design	4-Seats Design	2-Seats Design	2-Seats Design
Ball Configuration	L-, T-Port	L-, T, I-Port	Ball Configuration	L-, T-Port	L-, T-Port	L-, T-Port	L-, T-Port
Materials	CF8M / WCB	CF8M / WCB	Materials	CF8M	CF8M	CF8M / WCB	CF8M / WCB
End Connections	Flanged	TH.SW.BW.Flanged	End Connections	Threaded	Threaded	TH.SW.BW.FL	TH.SW.BW.FL
Pressure	ANSI 150#, 300# DIN PN 16 - 40 JIS 10K, 20K	800/ 1000 PSI ANSI 150#, 300# DIN PN 16 - 40	Pressure	1000PSI	800 / 1000PSI	1500 / 2000PSI	1500 / 2000PSI

SERIES 33	ANSI FLANGE PN16 FLANGE PN25 FLANGE PN40 FLANGE THREADED SOCKET WELD BUTT WELD Pressure Testing Mounting Pad Material CE Approval	ASME B16.5 DIN 2543 DIN 2544 DIN 2545 DIN 2549 NPT- ASME B1.20.1 , BSPP- ISO 228 , BSPT- ISO 7 , DIN2999 ANSI B16.11 ANSI B16.25 API 598 ISO 5211 ASTM A351-CF8M-EN 10213 1.4408 , Carbon Steel , 316L PED 2014/68/EU ISO 5209
ALL	MARKING	

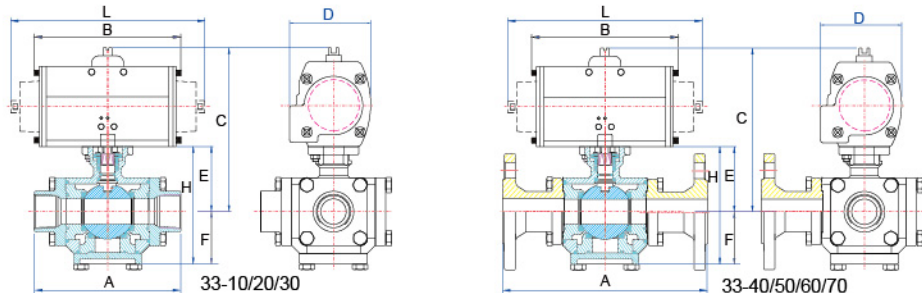

Double-Acting (80 Psi)

Valve Size	A	A 150#	A PN	B	C	D	E	F	H	Actuator	Wt		150# (Wt)		PN (Wt)		Remark
										Lbs.	Kg.	Lbs.	Kg.	Lbs.	Kg.		
1/4"	92			120	127.9	62.2	43.9	35.1	79	A-125	5.07	2.3					
3/8"	92			120	127.9	62.2	43.9	35.1	79	A-125	5.07	2.3					
1/2"	92	150	165	120	127.9	62.2	43.9	35.1	79	A-125	4.85	2.2	7.8	3.54	9.92	4.5	
3/4"	110	175	190	144.3	153.2	81.4	54.2	45.3	99.5	A-250	9.11	4.13	13.43	6.09	16.93	7.68	
1"	144	205	220	149.2	182.1	95	64.1	56.8	120.9	A-450	14.59	6.62	18.92	8.58	23.02	10.44	+ □
1 1/4"	146	215	235	149.2	196.5	95	78.5	59.8	138.3	A-450	17.09	7.75	25.55	11.59	31.97	14.5	
1 1/2"	164	255	270	183	235.9	119	94.9	72.3	167.2	A-1000	30.25	13.72	40.26	18.26	45.55	20.66	
2"	184	280	290	183	242.6	119	101.6	80.5	182.1	A-1000	36.38	16.5	51.02	23.14	56.57	25.66	
2 1/2"	228	325	330	259.6	281	140.5	120	96.8	216.8	A-2250	62.22	28.2	85.85	38.91	87.57	39.69	+ □
3"	265	345	340	259.6	293.9	140.5	132.9	105	237.9	A-2250	77.78	35.28	109.42	49.63	110.7	50.23	
4"	317	403	403	304.3	360	185.2	164	131.5	295.5	A-3650	157.07	71.19	202.34	91.71	191.68	86.88	+ □

Spring-Return (80 Psi)

Valve Size	A	A 150#	A PN	B	C	D	E	F	H	Actuator	Wt		150# (Wt)		PN (Wt)		Remark
										Lbs.	Kg.	Lbs.	Kg.	Lbs.	Kg.		
1/4"	92			194.6	142.9	81.4	43.9	35.1	79	A-250SR4	7.05	3.2					+ □
3/8"	92			194.6	142.9	81.4	43.9	35.1	79	A-250SR4	7.05	3.2					+ □
1/2"	92	150	165	194.6	142.9	81.4	43.9	35.1	79	A-250SR4	6.83	3.1	9.79	4.44	11.9	5.4	+ □
3/4"	110	175	190	205.6	172.2	95	54.2	45.3	99.5	A-450SR4	11.97	5.43	16.29	7.39	19.8	8.98	+ □
1"	144	205	220	250.0	205.1	119	64.1	56.8	120.9	A-1000SR4	21.21	9.62	25.53	11.58	29.63	13.44	+ □
1 1/4"	146	215	235	355.0	239.5	140.5	78.5	59.8	138.3	A-2250SR4	34.27	15.55	42.74	19.39	49.15	22.3	+ □
1 1/2"	164	255	270	355.0	255.9	140.5	94.9	72.3	167.2	A-2250SR4	44.14	20.02	54.15	24.56	59.44	26.96	+ □
2"	184	280	290	422.0	297.6	185.2	101.6	80.5	182.1	A-3650SR4	67.88	30.8	82.51	37.44	88.07	39.96	+ □
2 1/2"	228	325	330	422.0	316	185.2	120	96.8	216.8	A-3650SR4	85.38	38.7	109	49.41	110.73	50.19	+ □
3"	265	345	340	642.0	396.6	238.2	132.9	105	237.9	A-11000SR4	171.43	77.78	203.05	92.13	204.38	92.73	&
4"	317	403	403	642.0	427.7	238.2	164	131.5	295.5	A-11000SR4	234.04	106.19	279.27	126.71	268.62	121.88	&

Electric Actuator

& Mounting kit required.

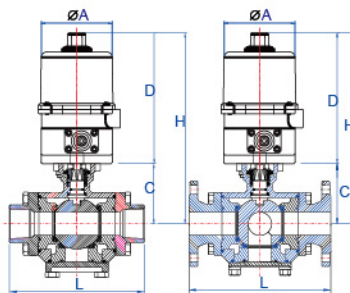

VALVE SIZE	Electric Actuator	Flange Type	ØA	C	D	H	L	STEM	Lbs.	Kg	150# L	PN L	150# Lbs.	150# Kg.	PN Lbs.	PN Kg	ISO 5211	Remark	
1/4"	OM-1	F03/F05	14	106	43.9	150	193.9	92	9	7.28	3.3						F03/F04/F05	+ □	
3/8"	OM-1	F03/F05	14	106	43.9	150	193.9	92	9	7.28	3.3						F03/F04/F05	+ □	
1/2"	OM-1	F03/F05	14	106	43.9	150	193.9	92	9	7.06	3.2	150	165	10.02	4.54	12.13	5.5	F03/F04/F05	+ □
3/4"	OM-1	F03/F05	14	106	54.2	150	204.2	110	11	9.99	4.53	175	190	14.32	6.49	17.83	8.08	F04/F05	+ □
1"	OM-A	F05/F07	17	106	64.1	196	260.1	144	11	7.42	7.42	205	220	20.70	9.38	24.80	11.24	F04/F05/F07	+ □
1 1/4"	OM-A	F05/F07	17	106	68.4	196	264.4	146	14	8.55	8.55	215	235	27.34	12.39	33.76	15.3	F05/F07	+ □
1 1/2"	OM-2	F07	22	181	94.9	255	349.9	164	17	46.38	21.02	255	270	56.39	25.56	61.75	27.99	F07/F10	+ □
2"	OM-3	F07	22	181	101.6	255	356.6	184	17	52.51	23.8	280	290	67.16	30.44	72.72	32.96	F07/F10	+ □
2 1/2"	OM-3	F07	22	181	120	255	375	228	17	69.94	31.7	325	330	93.57	42.41	95.29	43.19	F07/F10	+ □
3"	OM-4	F10	35	217	132.9	317	449.9	265	22	109.83	49.78	345	340	141.49	64.13	142.81	64.73	F10/F12	+ □
4"	OM-4	F10	35	217	164	317	481	320	22	172.51	78.19	403	403	217.78	98.71	207.13	93.88	F10/F12	+ □



MARS VALVE CO., LTD.
 83, Sec.1, Chung-De 8th Road,
 Taichung 406, Taiwan R.O.C.
 Tel : 886-4-2246 3808
 Fax : 886-4-2247 0912
 E-mail : mars@marsvalve.com.tw
 http://www.marsvalve.com.tw

Distributed by: